

***ECO* NIX**

línea mobiliario oficina

Disponible en versión de estructura cerrada. Se pueden realizar conjuntos de dirección y de multipuesto en este caso especializados para espacios de trabajo diáfanos con una gran atractivo y conectividad entre ellos.

Available in closed structure version. In this case specialized management and multi-user groups can be created for open work spaces with attractive and connectivity between them.

Disponible en version à structure fermée. Dans ce cas, des groupes de gestion spécialisés et des groupes multi-utilisateurs peuvent être créés pour les espaces de travail ouverts avec un grand attrait et une connectivité entre eux.



ECO_{NIX} con estructura en blanco RAL 9003, tapa de melamina de 25 mm acabado en nogal con un separador en vidrio de 3+3

ECO_{NIX} with structure in white RAL 9003, melamine top of 25 mm finished in walnut with a melamine separator in 3+3 glass

ECO_{NIX} avec structure en RAL 9003 blanc, plateau en mélaminé de 25 mm fini en noix avec un séparateur en mélamine en verre 3+3

*Composición especial con tapa angulada

*Special composition with angled top

*Composition spéciale avec top incliné

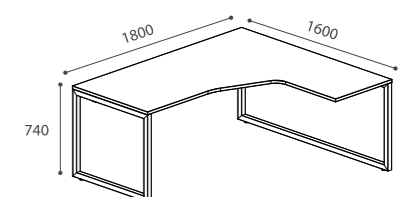

ECO_{nix} una mesa aparentemente sencilla pero con mucha funcionalidad y muy versatil a los nuevos conceptos de puestos de trabajo.

ECO_{nix} a table apparently simple but with much functionality and very versatile to the new concepts of jobs.

ECO_{nix} une table apparemment simple mais avec beaucoup de fonctionnalités et très polyvalente aux nouveaux concepts d'emplois.

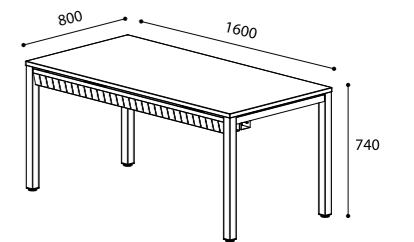

ECO_{nix} con carril electrificado con acabados en estructura en blanco text 9003 y tapa mesa en ceniza

ECO_{nix} with electrified lane with finishes in structure in white text 9003 and table top in ash

ECO_{nix} avec voie électrifiée avec finitions en structure en texte blanc 9003 et plateau en cendre

En el caso de este multipuesto se han seccionado las patas centrales para dotarlas con un mueble auxiliar que hace la función estructural, de archivo y de asiento. De esta forma se consigue concentrar el espacio de trabajo.

In the case of this workstation, the central legs have been sectioned to provide them with an auxiliary unit that performs the structural, archival and seating functions. In this way you can concentrate the workspace.

Dans le cas de cette position multiple, les pieds centraux ont été sectionnés pour leur fournir une unité auxiliaire qui remplit les fonctions de structure, d'archivage et d'assise. De cette façon, vous pouvez concentrer l'espace de travail.



ECO_{NIX} con estructura en negro en el RAL 9005 text, tapa de melamina de 25 mm acabado en blanco y mueble auxiliar en nogal y blanco

ECO_{NIX} with structure in black in the RAL 9005 text, melamine top of 25 mm finished in white and auxiliary furniture in walnut and white

ECO_{NIX} avec structure en noir dans le texte RAL 9005, plateau en mélaminé de 25 mm fini en blanc et meubles auxiliaires en noyer et blanc

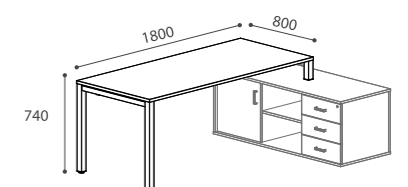

*ECO*nix tiene una serie de accesorios como separadores para crear multipuestos singulares privatizando los puestos de trabajo pero a su vez poder estar comunicado con el resto de puestos.

*ECO*nix has a series of accessories as front screen tors to create unique workstation privatizing the jobs but in turn be able to be connected with the rest of positions.

*ECO*nix a une série d'accessoires comme séparateurs pour créer des positions multiples uniques privatisant les emplois mais à son tour être en mesure d'être connecté avec le reste des positions.



*ECO*nix con estructura negra en RAL 9005 text y tapa de melamina de 25 mm acabado en cerezo

*ECO*nix with graphite structure in RAL 7024 text and melamine top of 25 mm finished in cherry

*ECO*nix avec structure en graphite dans le texte RAL 7024 et plateau en mélamine de 25 mm fini en cerisier

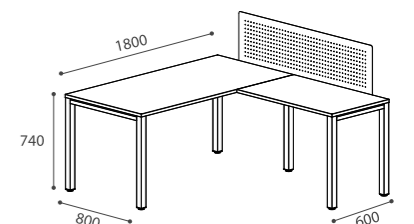

Composición multipuesto con buck móvil.

Workstation composition with mobile buck.

Composition multiproposée avec buck mobile.



Negro RAL 9005 text y tapa de melamina de 25 mm acabado en roble.



ECO**nix** con estructura en blanco RAL 9003 text y tapa de melamina de 25 mm en blanco

ECO**nix** with structure in white RAL 9003 text and 25 mm melamine top in white

ECO**nix** avec structure en texte RAL 9003 blanc et plateau en mélamine 25 mm en blanc

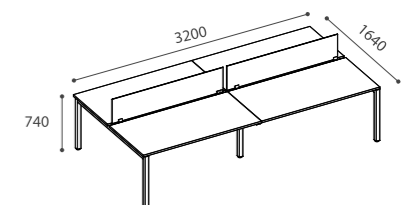

Adapta es nuestro módulo mostrador combinable con faldones y con mesas de todas las series.

Adapta is our counter module combinable with modesty pannel and with tables of all series.

Adapta C'est notre module de compteur qui peut être combiné avec des jupes et des tables de toutes les séries.



Adapta con estructura blanca en el RAL 9003 text y tapa de melamina acabado en nogal 17. Conjunto con faldón en melamina

Adapta with white structure in RAL 9003 text and melamine top walnut 17 finish . Set with melamine modesty pannel

Adapta avec structure blanche en texte RAL 9003 et plateau en mélamine fini noyer 17. Ensemble avec jupe en mélamine



Negro RAL 9005 text y tapa de melamina de 25 mm acabado en haya.

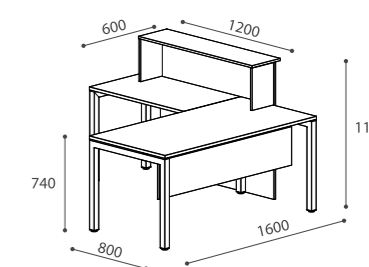

ECO alta se utiliza cada vez es más por su versatilidad y para crear zonas de trabajo colaborativas. Es un nuevo concepto de oficina moderna utilizado en empresas de diferente índole como laboratorios, cafeterías, salas de reuniones, offices, etc...

ECO high is used increasingly is more for its versatility and to create collaborative work areas. It is a new concept of modern office used in companies of different nature such as laboratories, cafeterias, meeting rooms, offices, etc ...

ECO high est de plus en plus utilisé est plus pour sa polyvalence et pour créer des zones de travail collaboratif. C'est un nouveau concept de bureau moderne utilisé dans des entreprises de nature différente telles que des laboratoires, des cafétérias, des salles de réunion, des bureaux, etc ...



ECO alta con estructura blanca en el RAL 9003 text y tapa de melamina de 25 mm acabado en arce

ECO high with white structure in RAL 9003 text and 25mm melamine top in maple finish

ECO haute avec structure blanche en texte RAL 9003 et plateau en mélaminé de 25 mm en finition érable

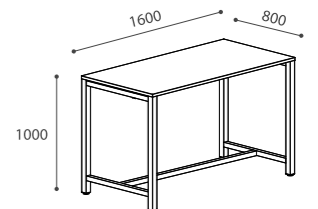

ECOnix reunión dispone de multiples de medidas para adaptarse a cualquier espacio.

ECOnix meeting it has multiple measures to adapt to any space.

ECOnix réunion il a plusieurs mesures pour s'adapter à n'importe quel espace.



ECO reunión con estructura blanca en el RAL 9003 text y tapa de melamina de 25 mm acabado en nogal.

ECO meeting with white structure in the RAL 9003 text and melamine top of 25 mm finished in walnut.

ECO réunion avec structure blanche dans le texte RAL 9003 et plateau en mélaminé de 25 mm fini en noyer.

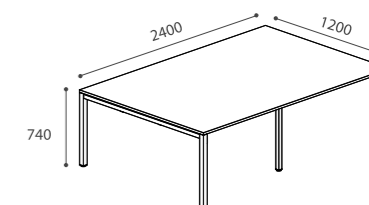

ECO nix combina facilmente con muebles auxiliares para una mejor simbiosis entre el archivo y puesto de trabajo.

ECO nix it combines easily with auxiliary furniture for a better symbiosis between the archive and the workplace.

ECO nix il se combine facilement avec des meubles auxiliaires pour une meilleure symbiose entre les archives et le lieu de travail.



ECOnix con un mueble auxiliar complementario y las patas remetidas con apoyo en el mueble. Acabados en arce y en plata RAL 9006

ECOnix with a complementary auxiliary furniture and the legs tucked with support in the furniture. Finishes in maple and silver RAL 9006

ECOnix avec un complément de mobilier auxiliaire et les jambes nichées avec le soutien dans les meubles. Finitions en érable et argent RAL 9006

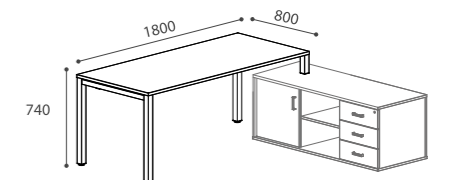

Nuestra línea de complementos y/o accesorios es muy amplia y configurable como soportes para CPU, electrificación, vertebrae, pasacables, etc...

Our line of accessories is very broad and configurable as supports for CPU, management electrification, vertebrae, cable grommet, etc ...

Notre gamme d'accessoires est très large et configurable comme support pour CPU, électrification de gestion, vertèbres, câble à œillets, etc.



ECOnix Estructura grafito en el RAL 7024 y tapa de melamina de 25 mm acabado en ceniza

ECOnix Graphite structure in RAL 7024 and melamine top of 25 mm finished in ash

ECOnix Structure graphite en RAL 7024 et plateau en mélamine de 25 mm fini en cendres

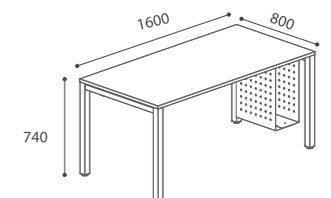

ARCO largo fondo alto

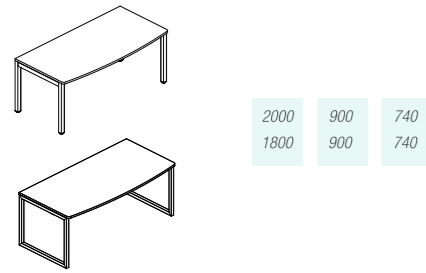

2000	900	740
1800	900	740

RECTA

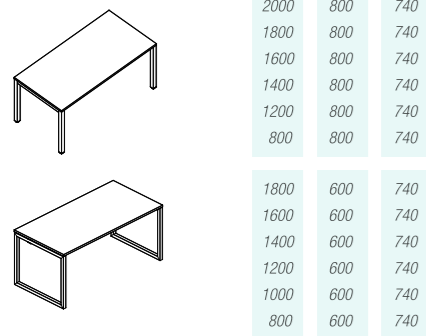

2000	800	740
1800	800	740
1600	800	740
1400	800	740
1200	800	740
800	800	740
1800	600	740
1600	600	740
1400	600	740
1200	600	740
1000	600	740
800	600	740

RECTA 3 PATAS + APOYO

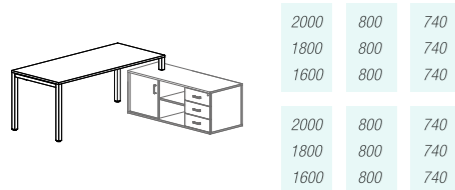

2000	800	740
1800	800	740
1600	800	740
2000	800	740
1800	800	740
1600	800	740

RECTA 2 PATAS + APOYO

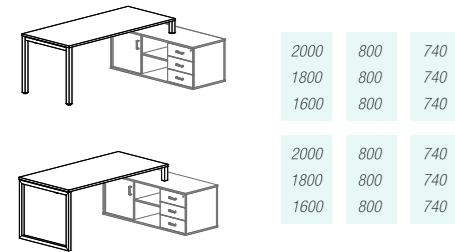

2000	800	740
1800	800	740
1600	800	740
2000	800	740
1800	800	740
1600	800	740

ALA

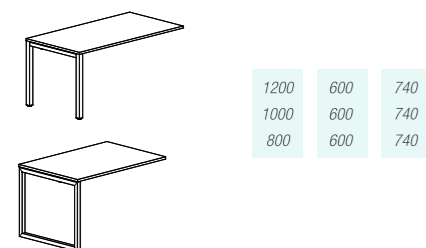

1200	600	740
1000	600	740
800	600	740

COMPACTA ANGULADA I largo fondo alto

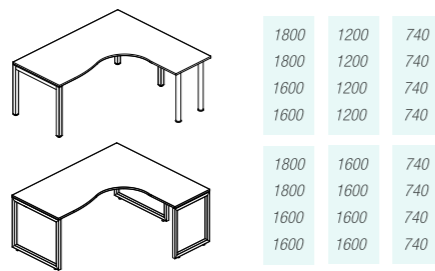

1800	1200	740
1800	1200	740
1600	1200	740
1600	1200	740
1800	1600	740
1800	1600	740
1600	1600	740
1600	1600	740

COMPACTA ANGULADA II

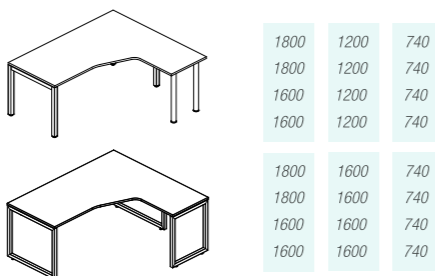

1800	1200	740
1800	1200	740
1600	1200	740
1600	1200	740
1800	1600	740
1800	1600	740
1600	1600	740
1600	1600	740

MULTIPUESTO INICIAL

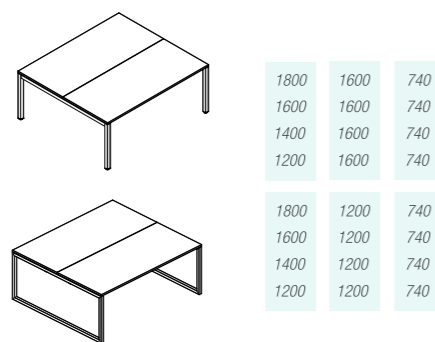

1800	1600	740
1600	1600	740
1400	1600	740
1200	1600	740
1800	1200	740
1600	1200	740
1400	1200	740
1200	1200	740

MULTIPUESTO EXTENSIÓN

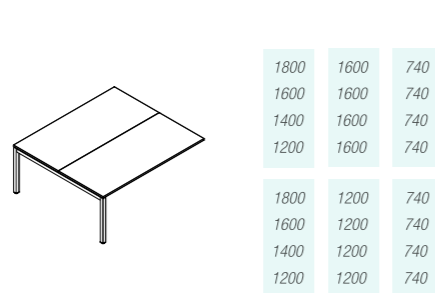

1800	1600	740
1600	1600	740
1400	1600	740
1200	1600	740
1800	1200	740
1600	1200	740
1400	1200	740
1200	1200	740

MULTIPUESTO INICIAL CON SEPARADOR largo fondo alto

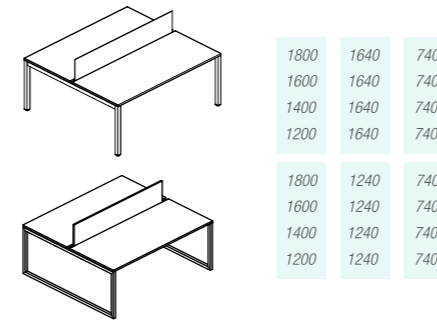

1800	1640	740
1600	1640	740
1400	1640	740
1200	1640	740
1800	1240	740
1600	1240	740
1400	1240	740
1200	1240	740

MESA EXTENSIÓN CON SEPARADOR

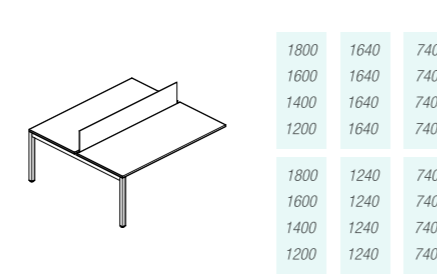

1800	1640	740
1600	1640	740
1400	1640	740
1200	1640	740
1800	1240	740
1600	1240	740
1400	1240	740
1200	1240	740

MESA EXTENSIÓN CON PATA REMETIDA

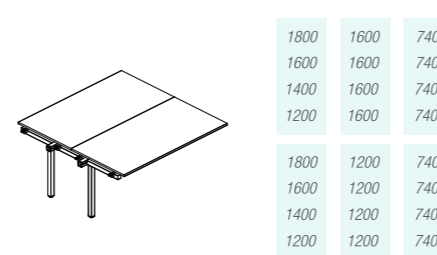

1800	1600	740
1600	1600	740
1400	1600	740
1200	1600	740
1800	1200	740
1600	1200	740
1400	1200	740
1200	1200	740

MESA EXTENSIÓN CON PATA REMETIDA

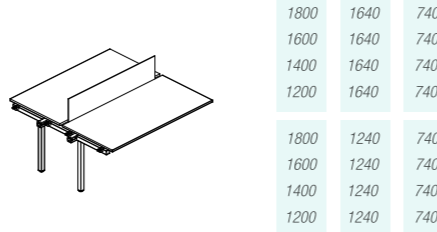

1800	1640	740
1600	1640	740
1400	1640	740
1200	1640	740
1800	1240	740
1600	1240	740
1400	1240	740
1200	1240	740

ECO REUNIÓN largo fondo alto

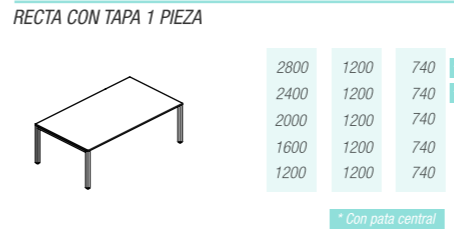

2800	1200	740
2400	1200	740
2000	1200	740
1600	1200	740
1200	1200	740

* Con pata central

RECTA REUNIÓN CON TAPA 2 PIEZAS

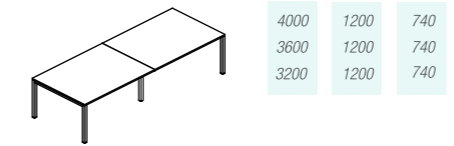

4000	1200	740
3600	1200	740
3200	1200	740

ADAPTA largo fondo alto

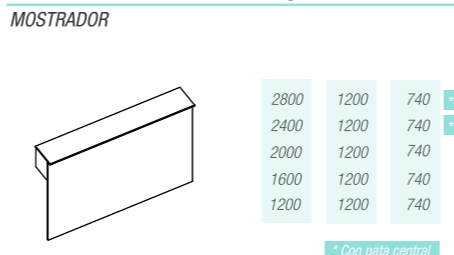

2800	1200	740
2400	1200	740
2000	1200	740
1600	1200	740
1200	1200	740

* Con pata central

MOSTRADOR 90°

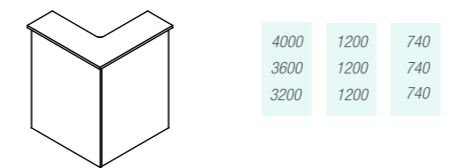

4000	1200	740
3600	1200	740
3200	1200	740

ECO ALTA largo fondo alto

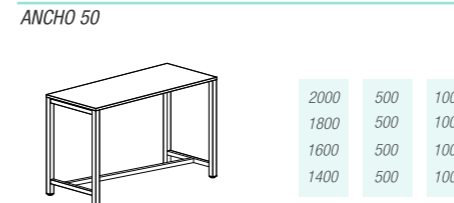

2000	500	1000
1800	500	1000
1600	500	1000
1400	500	1000

ANCHO 68

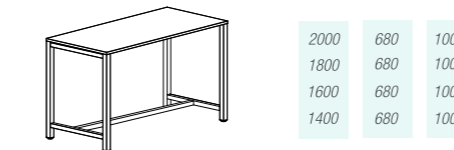

2000	680	1000
1800	680	1000
1600	680	1000
1400	680	1000

DIVISORIAS sobre separ. fondo alto

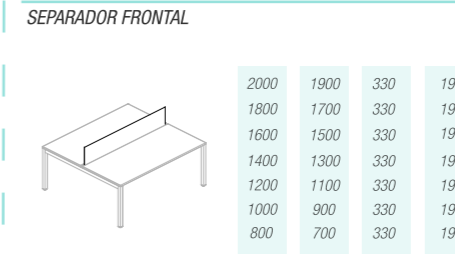

2000	1900	330	19
1800	1700	330	19
1600	1500	330	19
1400	1300	330	19
1200	1100	330	19
1000	900	330	19
800	700	330	19

SEPARADOR FRONTAL METACRILATO O CRISTAL

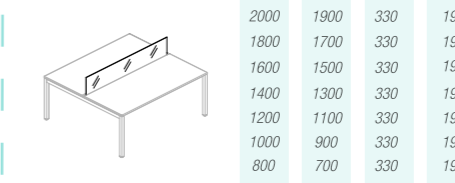

2000	1900	330	19
1800	1700	330	19
1600	1500	330	19
1400	1300	330	19
1200	1100	330	19
1000	900	330	19
800	700	330	19

SEPARADOR LATERAL CENTRAL largo fondo alto

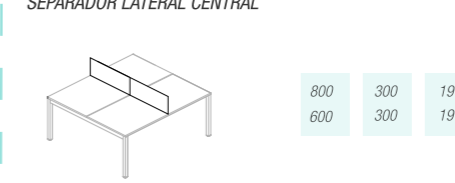

800	300	19
600	300	19

SEPARADOR LATERAL EXTREMO

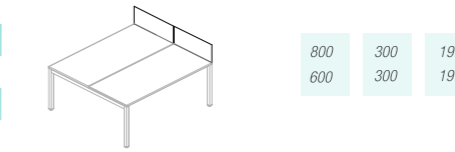

800	300	19
600	300	19

ANCHO 80 largo fondo alto

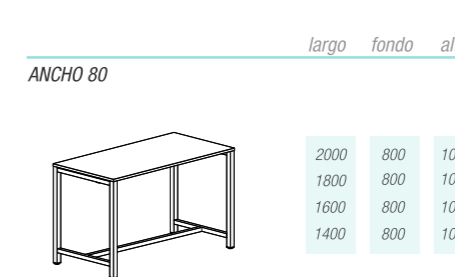

2000	800	1000
1800	800	1000
1600	800	1000
1400	800	1000

ANCHO 100

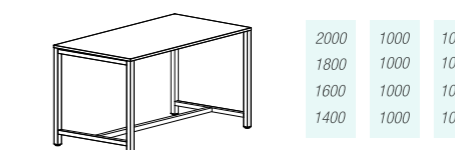

2000	1000	1000
1800	1000	1000
1600	1000	1000
1400	1000	1000

FALDONES sobre faldón alto

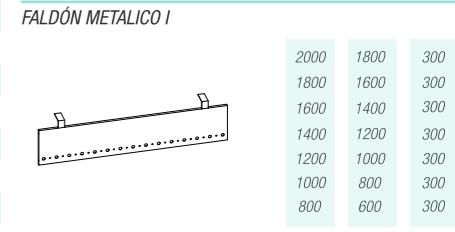

2000	1800	300
1800	1600	300
1600	1400	300
1400	1200	300
1200	1000	300
1000	800	300
800	600	300

FALDÓN METALICO II largo fondo alto

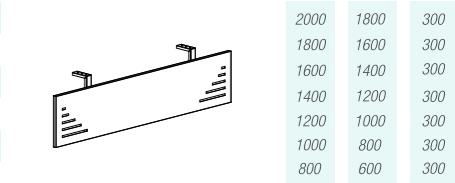

2000	1800	300
1800	1600	300
1600	1400	300
1400	1200	300
1200	1000	300
1000	800	300
800	600	300

FALDÓN MELAMINA largo fondo alto

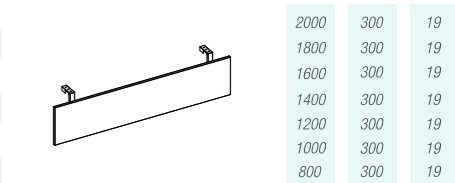

2000	300	19
1800	300	19
1600	300	19
1400	300	19
1200	300	19
1000	300	19
800	300	19

ELECTRIFICACIÓN largo fondo alto

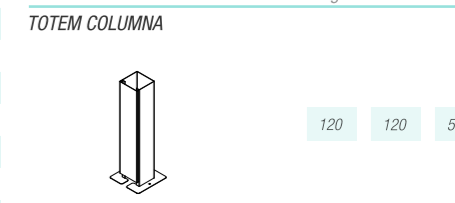

2000	120	580
------	-----	-----

BANDEJA ELECTRIFICADA VISTA *existen más bandejas en catálogo general

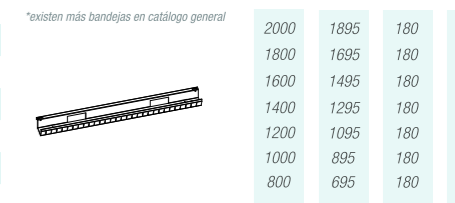

2000	1895	180	120
1800	1695	180	120
1600	1495	180	120
1400	1295	180	120
1200	1095	180	120
1000	895	180	120
800	695	180	120

TAPA ABATIBLE largo fondo

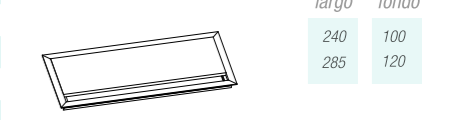

240	100
285	120

VERTICAL PATA largo fondo alto

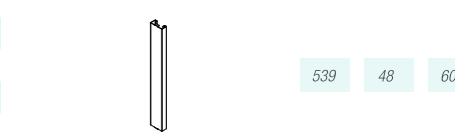

539	48	600
-----	----	-----

